

- ☒ = Schleifz.
- * = 0.5 mm
- = 0.5x45°
- X = 1 x45°
- = 1.5x45°
- ▽ = 2 x45°
- = R 0.5
- ⊗ = R 1
- = R 1.5
- ⌢ = R 2
- R = R 2.5

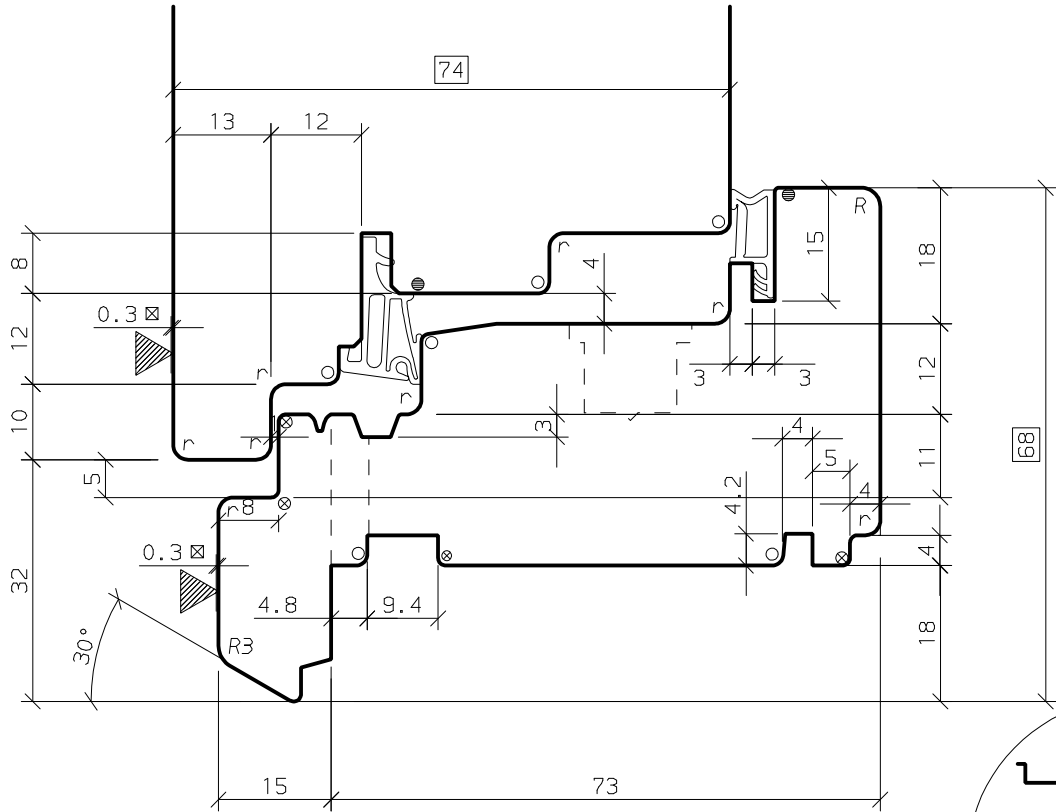

Variante

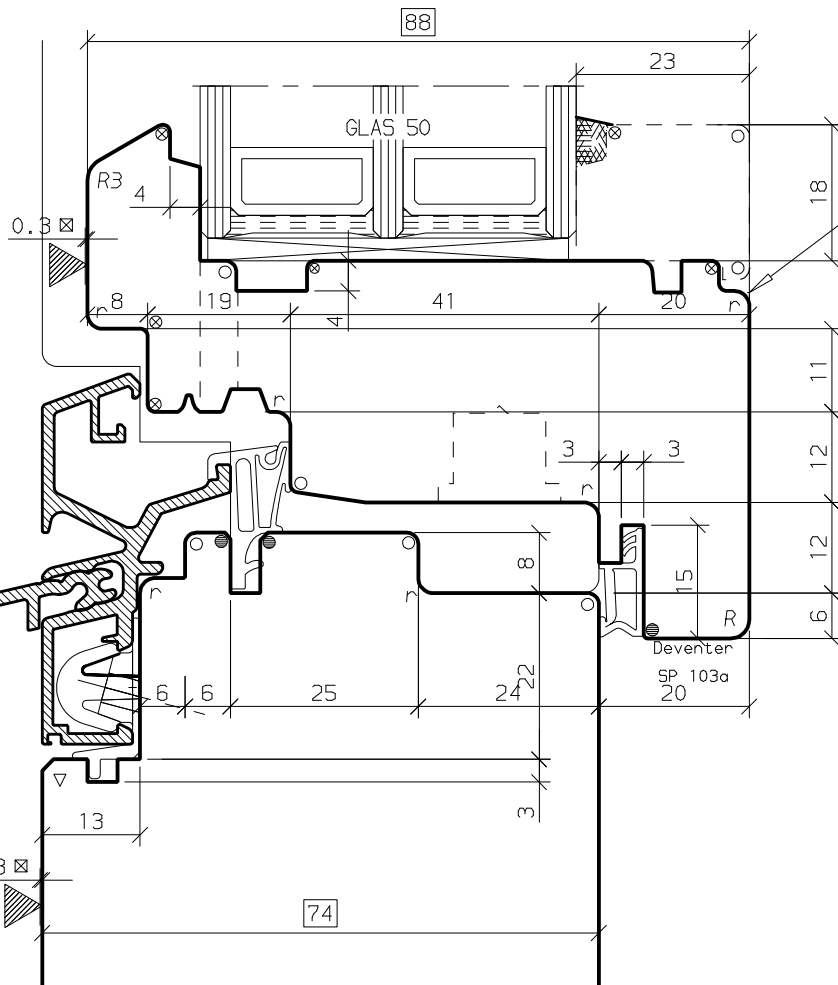
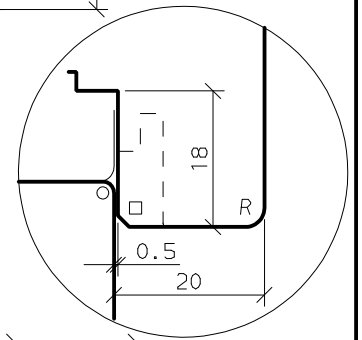

scharfkantig manuell

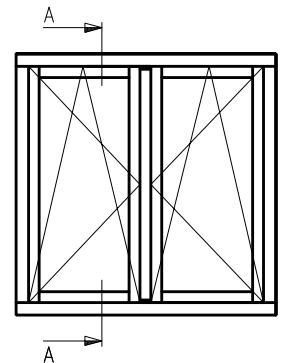

OERTLI

SIRIUS H 74/88
VERTIKALSCHNITT

Ers.d: .
Ers.f: .

Maßstab 1:1 A4 Gez. 15.03.18 LA0

K-Nr. 1001108 Gepr. .

K-Name SCHREINEREI WEBER, SEEWEN

QD 1518964 020 01 A

- ☒ = Schleifz.
- * = 0.5 mm
- = 0.5x45°
- X = 1 x45°
- = 1.5x45°
- ▽ = 2 x45°
- = R 0.5
- ⊗ = R 1
- = R 1.5
- r = R 2
- R = R 2.5

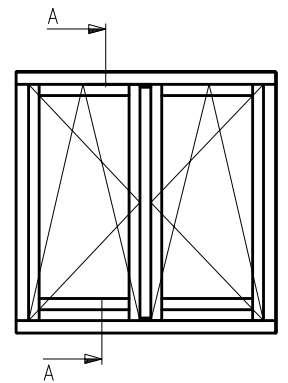
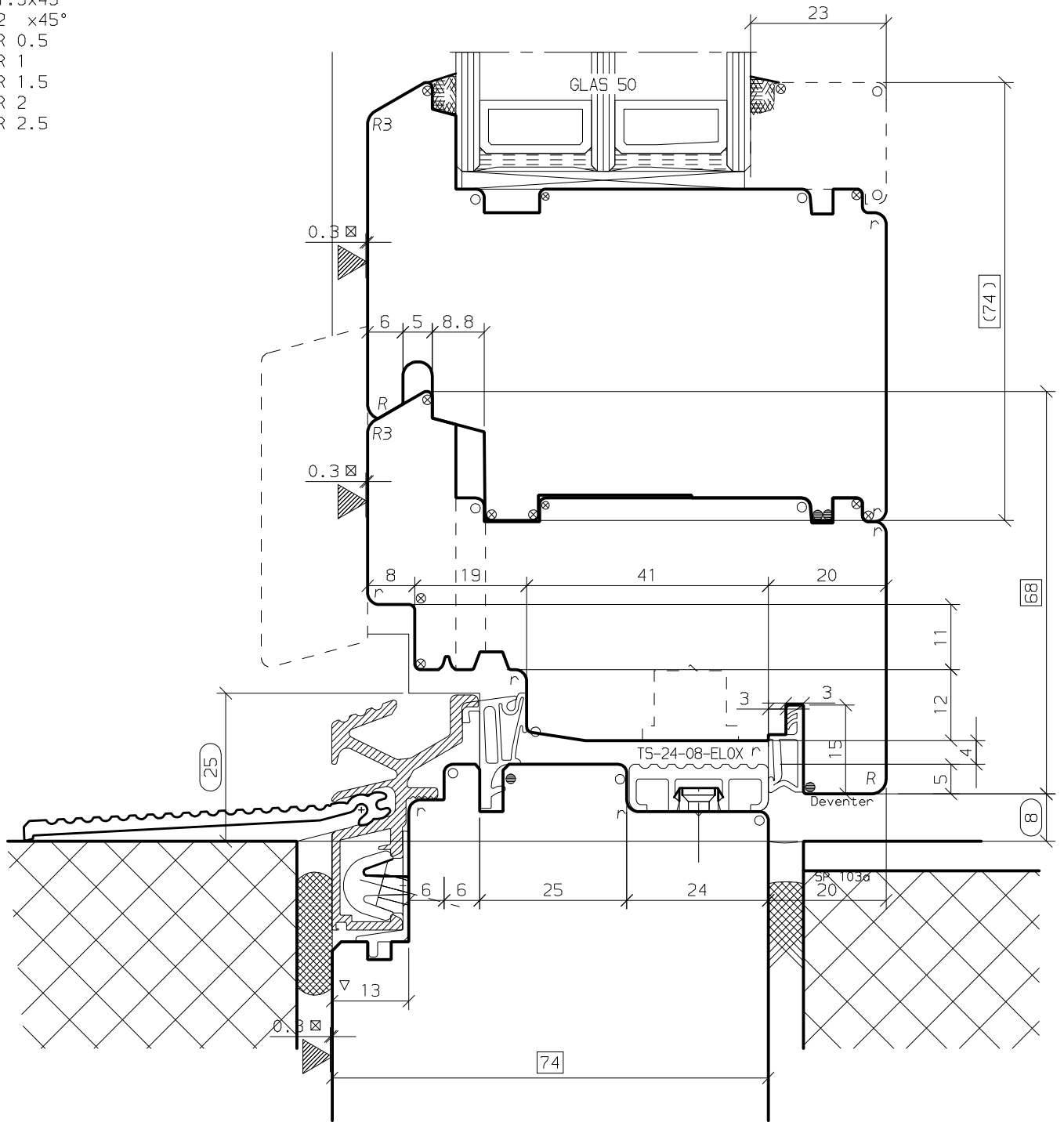

OERTLI	SIRIUS H 74/88 VERTIKALSCHNITT FLÜGELEINLEGER, NIEDERE SCHWELLE	Maßstab 1:1	A4 Gez.	15.03.18	LA0
	Ers.d.: Ers.f.:	K-Nr. 1001108 K-Name SCHREINEREI WEBER, SEEWEN	Gepr. .	.	QD 1518964 021 01 A

- ☒ = Schleifz.
- * = 0.5 mm
- = 0.5x45°
- × = 1 x45°
- = 1.5x45°
- ▽ = 2 x45°
- ⊙ = R 0.5
- ⊗ = R 1
- = R 1.5
- ⋄ = R 2
- R = R 2.5

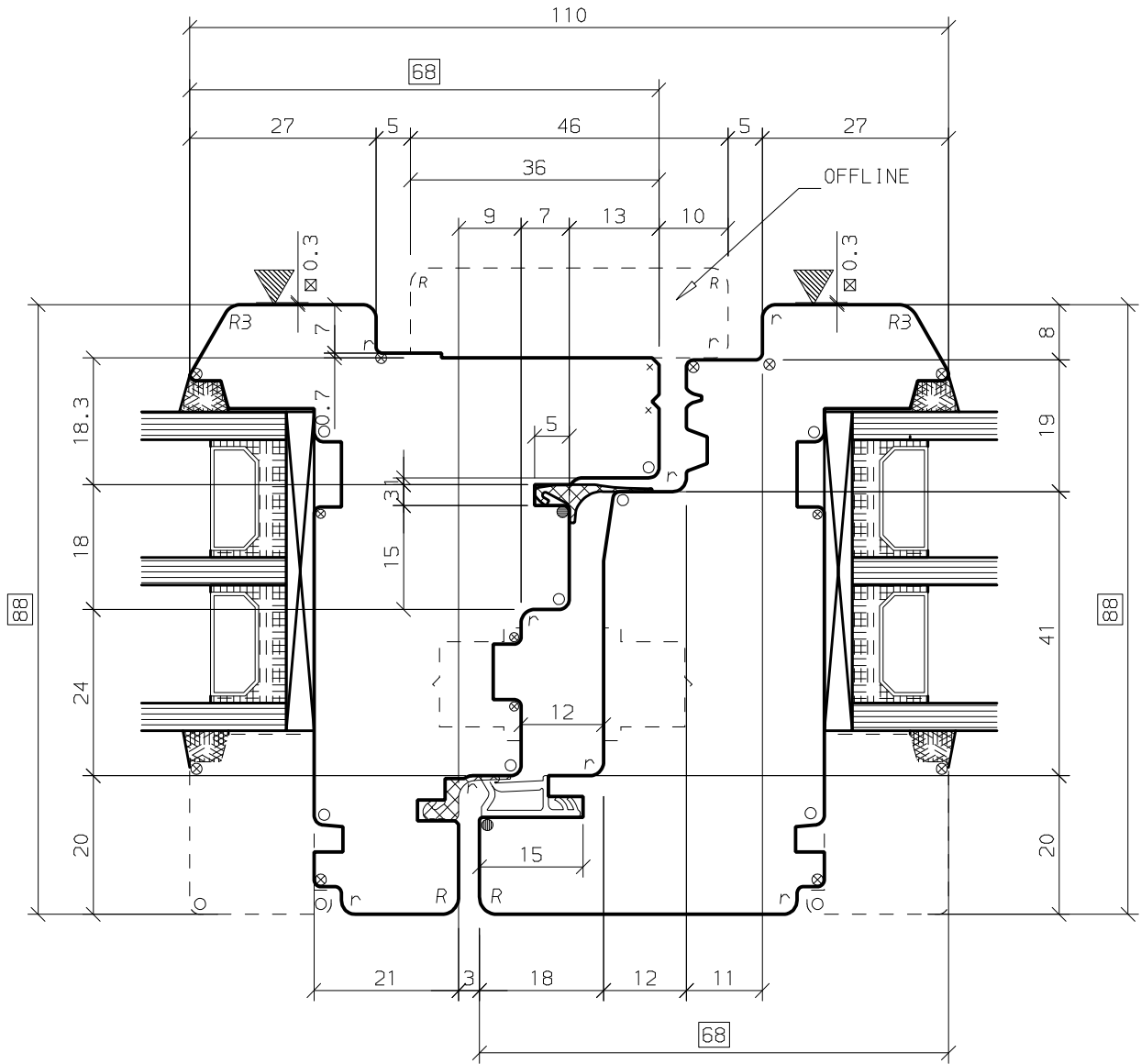

Eschbal
SD-1306-01

Deventer
SP 103a

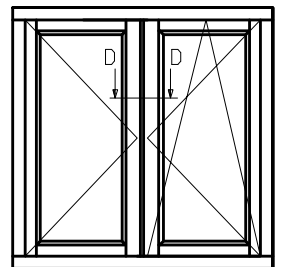
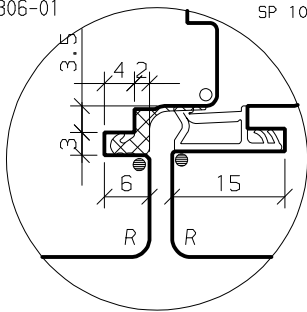

OERTLI

SIRIUS H 74/88
MITTELPARTIE
SCHLAGLEISTE AUFGESETZT

Maßstab 1:1 **A4** Gez. 15.03.18 LA0

K-Nr. 1001108 Gepr. . . .

K-Name SCHREINEREI WEBER, SEEWEN

QD 1518964 022 01 A

Ers.d.:
Ers.f.:

- ☒ = Schleifz.
- * = 0.5 mm
- = 0.5x45°
- X = 1 x45°
- = 1.5x45°
- ▽ = 2 x45°
- = R 0.5
- ⊗ = R 1
- = R 1.5
- r = R 2
- R = R 2.5

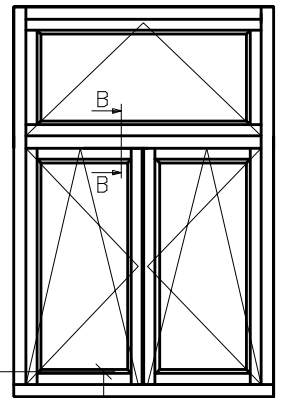

SCHNITT B-B

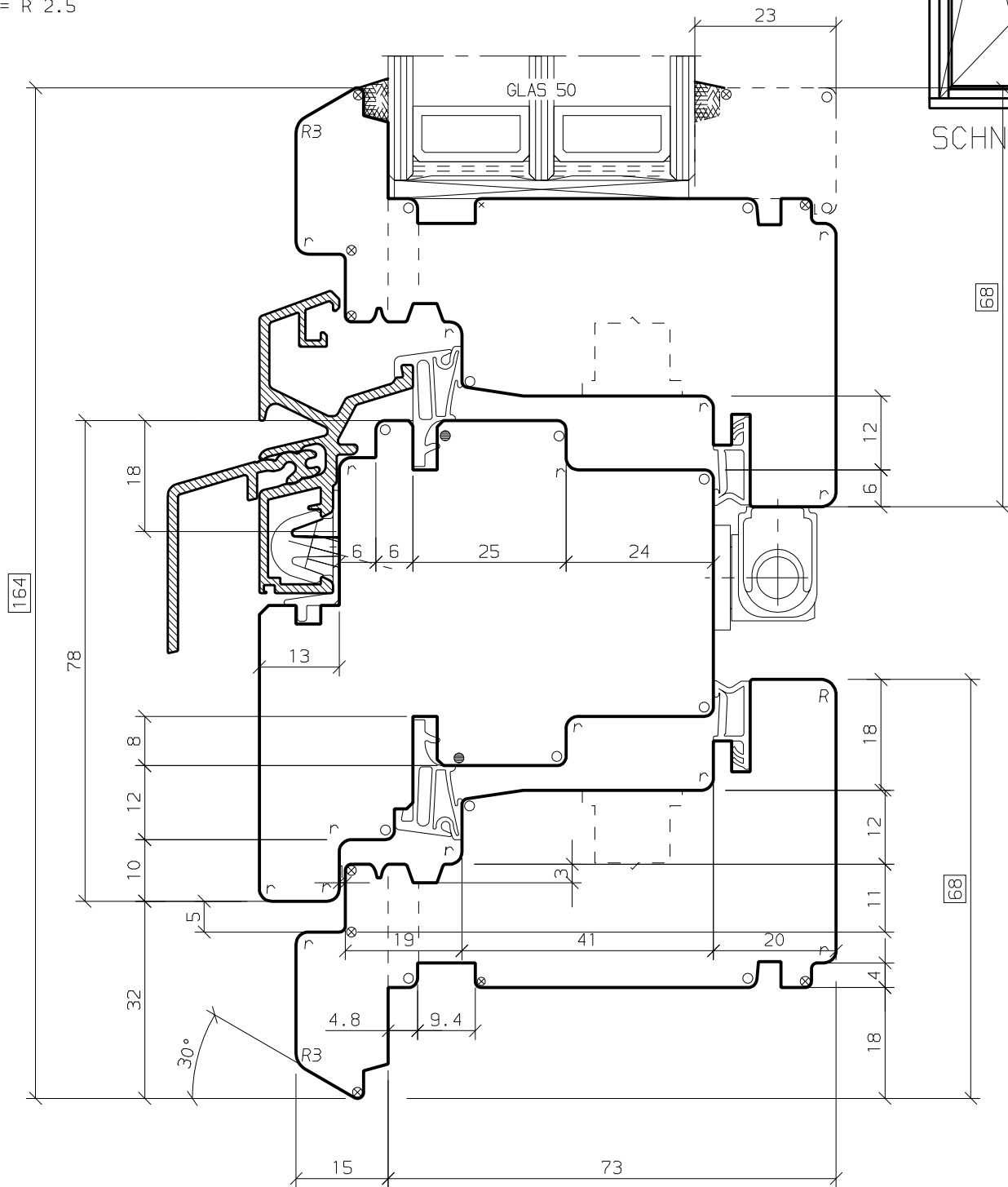

OERTLI

**SIRIUS H 74/88
KÄMPFER**

Ers. d.:
Ers. f.:

Maßstab 1:1 | A4 Gez. 15.03.18 | LA0

K-Nr. 1001108 | Gepr. .

K-Name SCHREINEREI WEBER, SEEWEN

QD 1518964 023 01 A

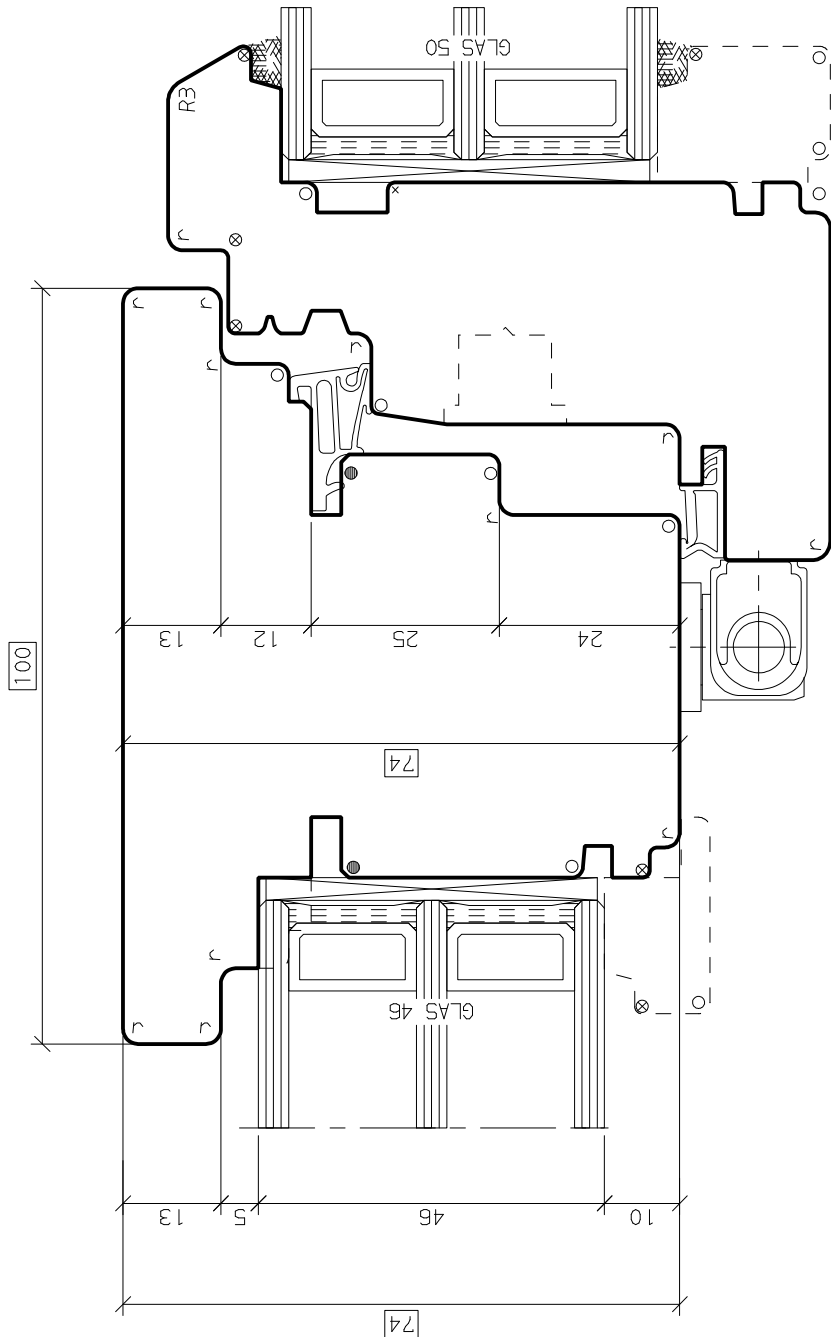

SIRIUS H 74/88
SETZHOLZ 100MM
FLÜGEL - FESTVERGLASUNG

Maßstab	1:1	A4	Gez.	05.11.18	LA0
K-Nr.	1001108	Gepr.			
K-Name	SCHREINEREI WEBER, SEEWEN				

QD 1518964 024 01 A

- ☒ = Schleifz.
- * = 0.5 mm
- = 0.5x45°
- × = 1 x45°
- = 1.5x45°
- ▽ = 2 x45°
- = R 0.5
- ⊗ = R 1
- = R 1.5
- r = R 2
- R = R 2.5

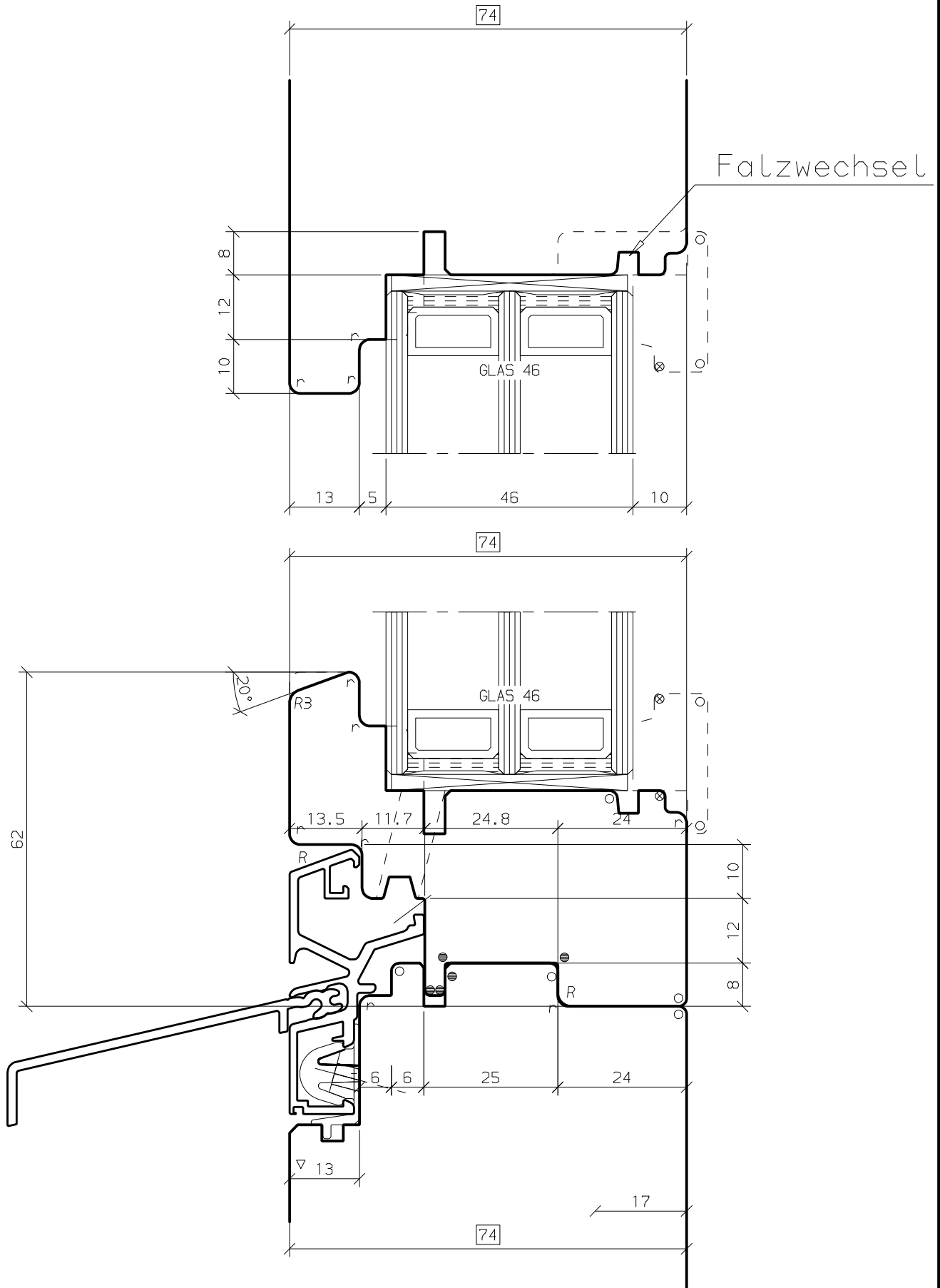

OERTLI 

Ers.d.:
Ers.f.:

SIRIUS H 74/88
FESTVERGLASUNG MIT EINLEIMER

Maßstab	1:1	A4 Gez.	15.03.18	LA0
K-Nr.	1001108	Gep.	.	.
K-Name	SCHREINEREI WEBER, SEEWEN			
QD 1518964 025 01 A				

- ☒ = Schleifz.
- * = 0.5 mm
- = 0.5x45°
- × = 1 x45°
- = 1.5x45°
- ▽ = 2 x45°
- ⊙ = R 0.5
- ⊗ = R 1
- = R 1.5
- r = R 2
- R = R 2.5

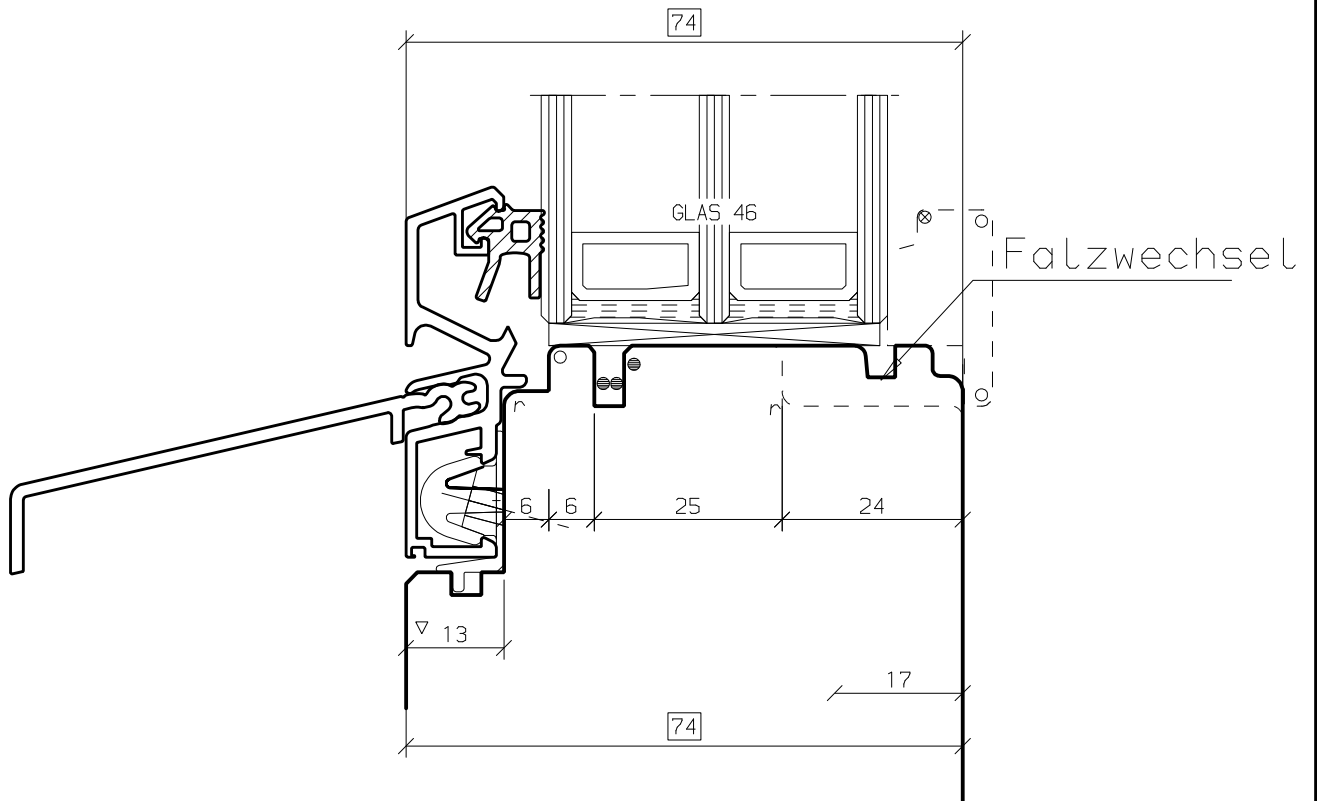
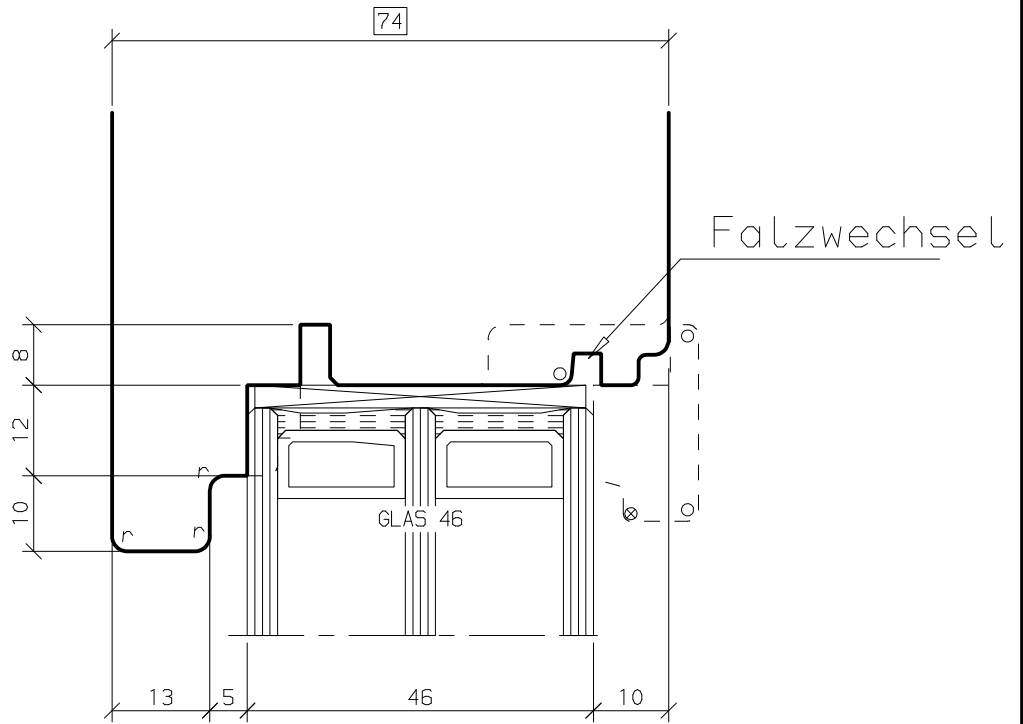

OERTLI

SIRIUS H 74/88
FESTVERGLASUNG OHNE EINLEIMER

Maßstab 1:1 **A4** Gez. 15.03.18 LA0

K-Nr. 1001108 Gepr. . . .

K-Name SCHREINEREI WEBER, SEEWEN

QD 1518964 026 01 A

Ers.d: .
 Ers.f: .

- ☒ = Schleifz.
- * = 0.5 mm
- = 0.5x45°
- × = 1 x45°
- = 1.5x45°
- ▽ = 2 x45°
- ⊙ = R 0.5
- ⊗ = R 1
- = R 1.5
- r = R 2
- R = R 2.5

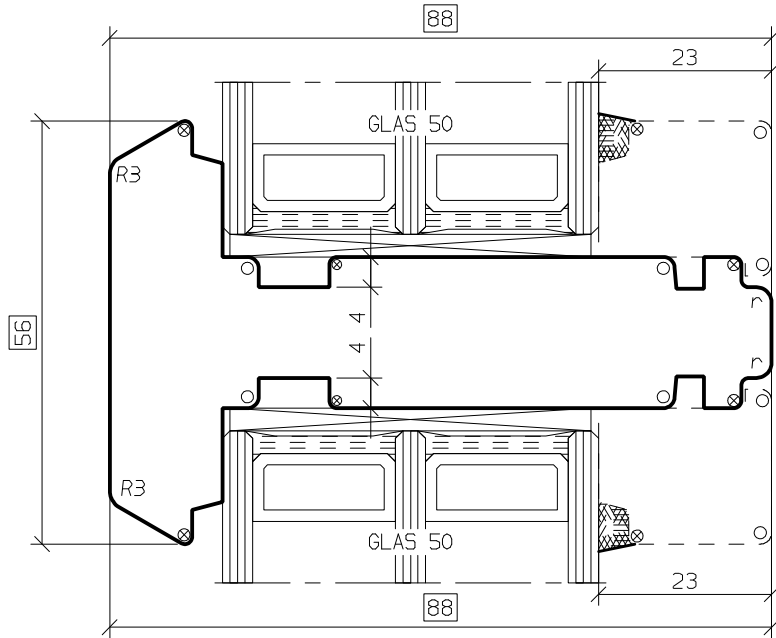

OERTLI 

SIRIUS H 74/88
SPROSSE GLASTRENNEND

Maßstab 1:1 **A4** Gez. 15.03.18 LA0

K-Nr. 1001108 Gepr. . .

K-Name SCHREINEREI WEBER, SEEWEN

QD 1518964 027 01 A

Ers.d: .
 Ers.f: .

- ☒ = Schleifz.
- * = 0.5 mm
- = 0.5x45°
- X = 1 x45°
- = 1.5x45°
- ▽ = 2 x45°
- = R 0.5
- ⊗ = R 1
- = R 1.5
- ⊖ = R 2
- R = R 2.5

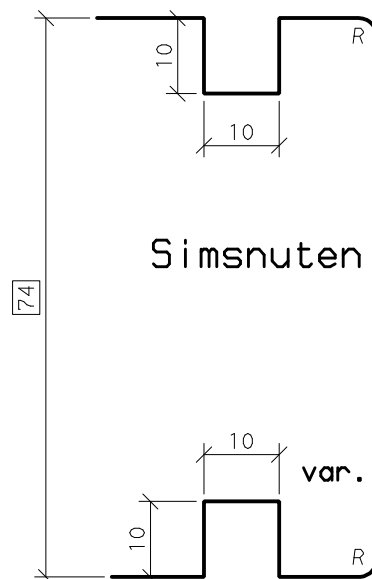
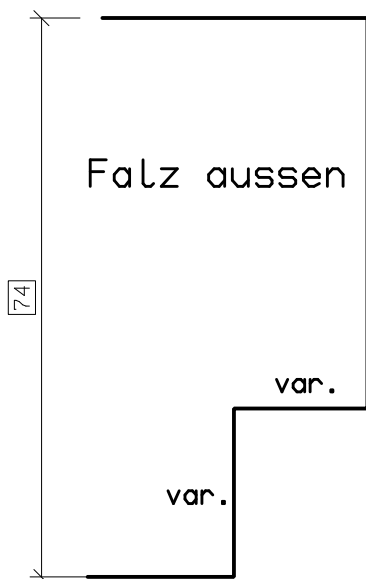
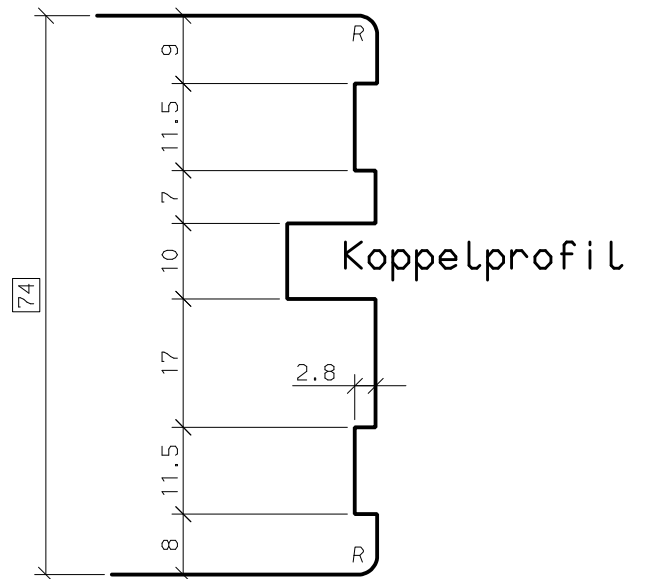
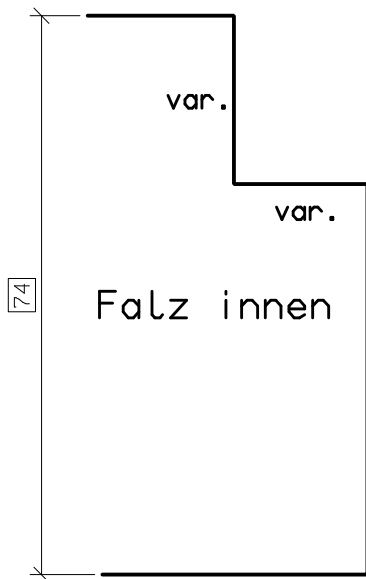
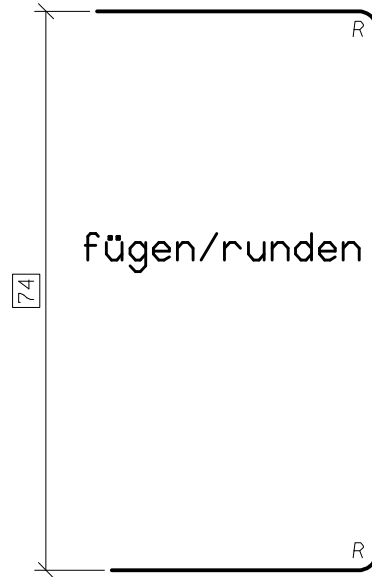

OERTLI

RAHMENAUSSENBEARBEITUNGEN
HD 74MM

Maßstab 1:1 **A4** Gez. 15.03.18 LA0

K-Nr. 1001108 Gepr. . .

K-Name SCHREINEREI WEBER, SEEWEN

QD 1518964 029 01 A

Ers.d: .
 Ers.f: .